



Barcode: 5060452080710

transbank™

Product code: TRB2

- » Fully welded unit, for storing and transporting fuels and chemicals.
- » Suitable for vehicle mounting in line with regulations.
- » Designed for storing 2 x 20 litre cans.



Watch the TransBank in action



Product features



Padlock secured



COSH H compliant



Sump capacity



Fire resistant



No detachable parts



Safety signage



Suitable for vehicles

Product specifications

Weight	20kg
Colour	Traffic red: RAL 3020
Suitable for	Transporting flammables & chemicals - 2 x 20L cans
Finished coating	Powder coated
Material & thickness	1.2mm steel
Quantity of keys	No
How are castors fitted?	Not applicable
Other sizes available	4 other sizes
Ventilation	Yes
Qty of shelves as standard	Not applicable

Dimensions

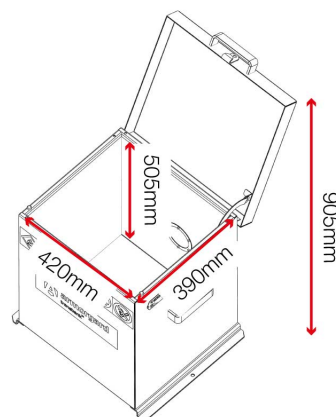
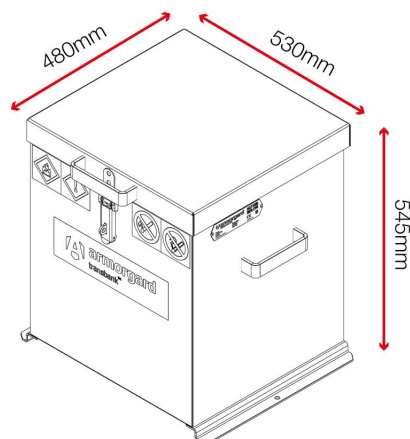

Optional extras - Contact Armorgard to find out more



Padlock LOCK-P50